



VOLUME RIDDLES 5B

The answer for each riddle is one of the cuboids below.

Find the correct answer to each, and success is within your reach!

- 1) • I am not a cube.
• I am less than 5cm high.
• My volume is more than 14cm^3 .
• My length and width are the same.
• Who am I?
- 2) • I am more than 1cm high.
• I have at least one square face.
• My volume is less than 20cm^3 .
• Only two of my dimensions are the same.
• Who am I?

Answer ____

Answer ____



A

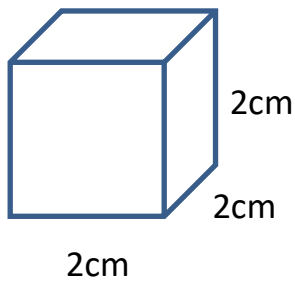

B

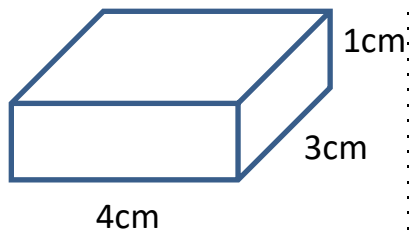

C

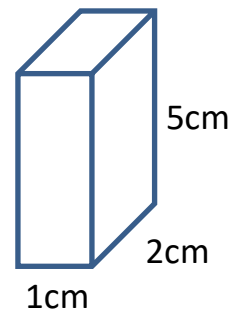

D

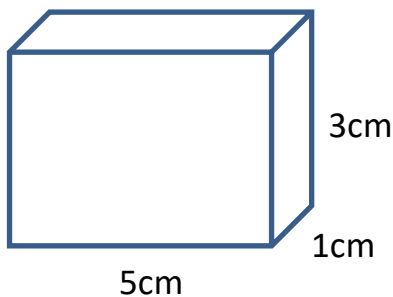

E

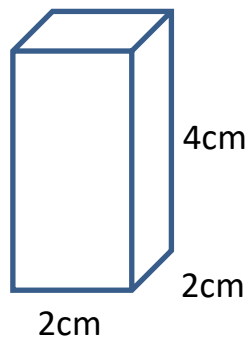

F

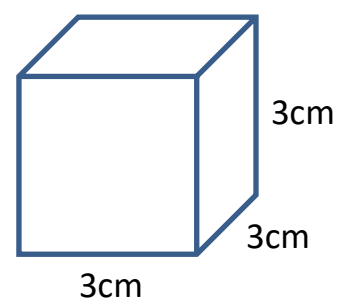

Name

Date



VOLUME RIDDLES 5B ANSWERS

- 1)
 - I am not a cube.
 - I am less than 5cm high.
 - My volume is more than 14cm^3 .
 - My length and width are not the same.
 - Who am I?
- 2)
 - I am more than 1cm high.
 - My volume is more than 10cm^3 .
 - I have at least one square face.
 - If you flip me over, my dimensions stay the same.
 - Who am I?

Answer D

Answer F

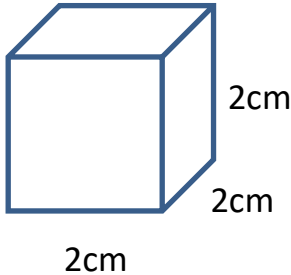
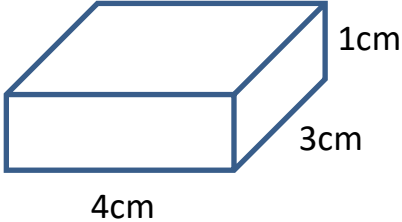
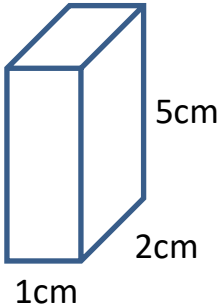
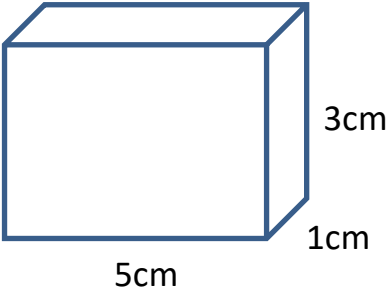
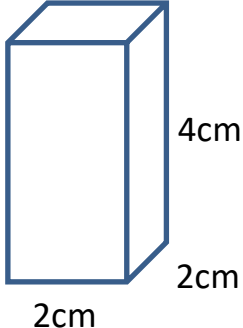

<p>A</p> 	<p>B</p> 	<p>C</p> 
<p>D</p> 	<p>E</p> 	<p>F</p> 